

**Screw Terminals (81-3114)**

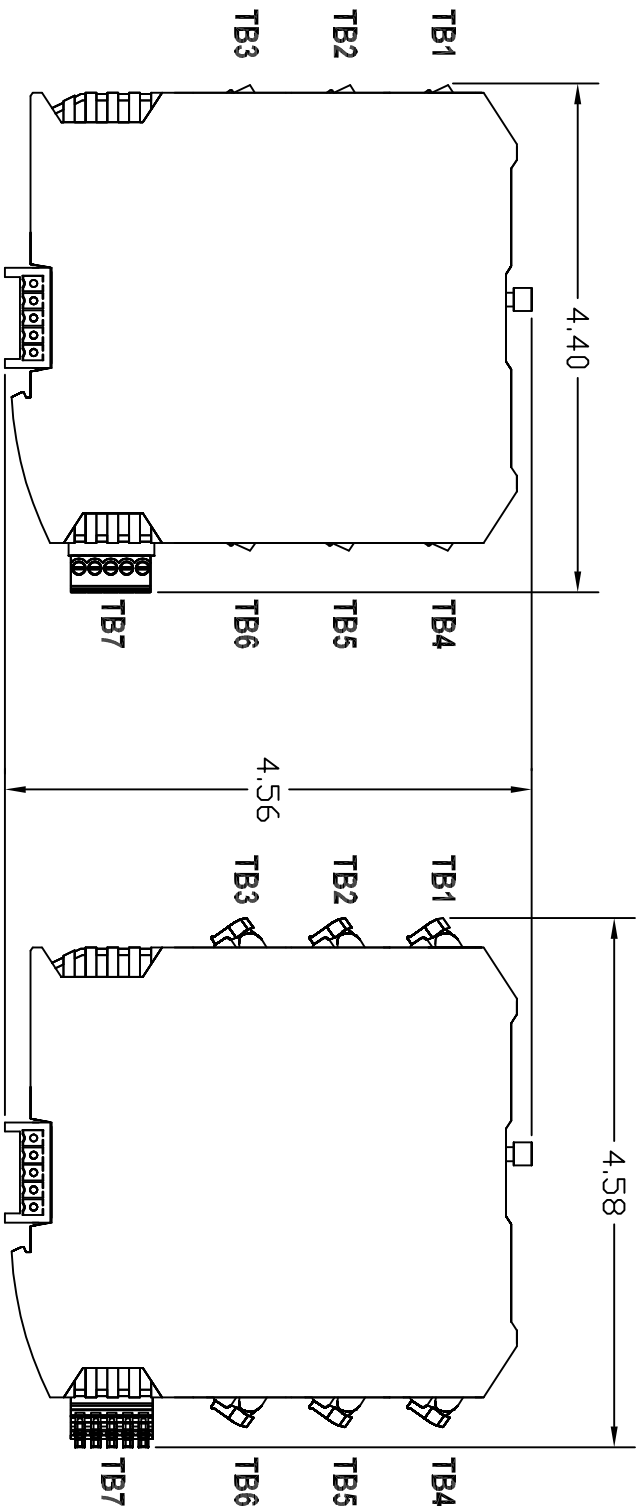

**Lever Terminals (82-3114)**

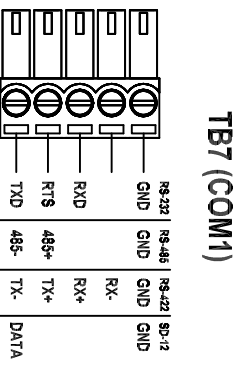
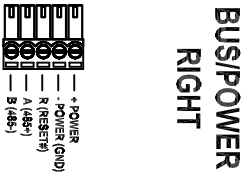
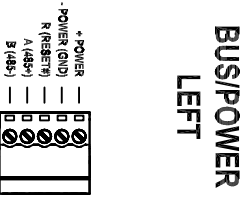
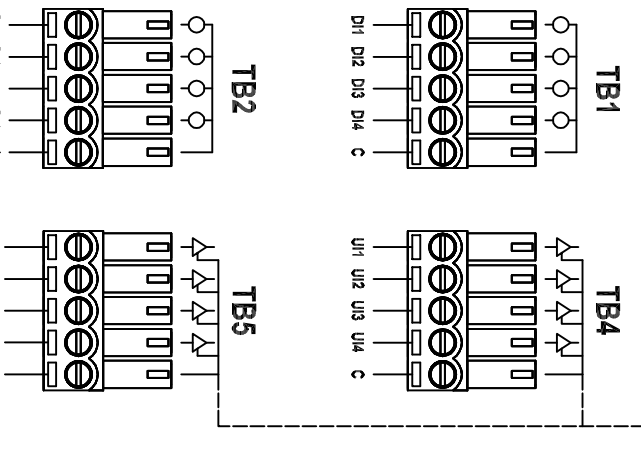

ZONE	REV	DESCRIPTION	DATE	APPROVED
		CONNECTED INTERNALLY		

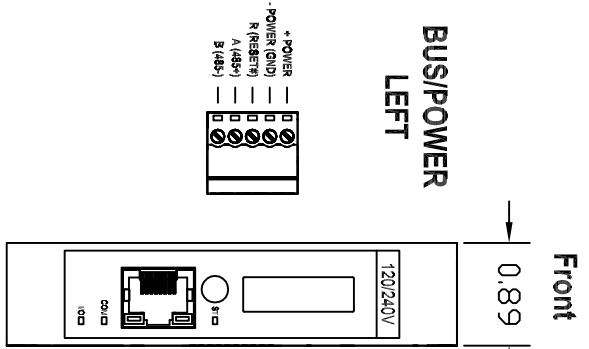
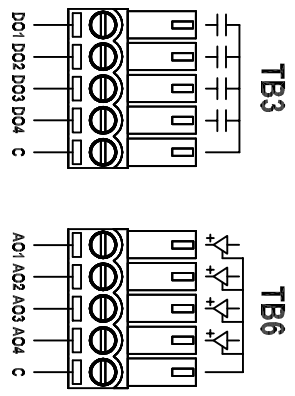

1384 Blue Oaks Blvd  
 Roseville, CA 95678  
 (530) 888-1800  
 WWW.CLINKS.COM

Industrial Control Links

MODULUS COMBO 120/240V 8x-3114

SIZE	FORM NO.	DRW NO.	REV
		61289001	AX1