

MODULUS

Serial Communications Module 1120 with UPS

Modulus Serial Communications modules provide up to three serial ports (bus port plus two general purpose ports) for interfacing with external radios, modems and intelligent control and monitoring devices such as variable frequency drives and power monitors. The bus port may also be used for general purpose RS-485 communications when not bussed with other Modulus I/O. Each port operates independently as a master or slave using industry-standard protocols such as Modbus, DF1, SDX, and SDI-12. The modules also have an Ethernet port supporting Modbus, Ethernet IP, MQTT, and SDX protocols.

The Serial Communications modules have built-in analog and digital I/O for tank level and process monitoring, and pump control applications such as wells, lift stations and booster pumping stations. The modules may be ordered with analog inputs supporting either mA, voltage or resistance/temperature measurement. In addition, they have five discrete inputs (one high-speed and four optically isolated), three discrete outputs, and two analog outputs.

Modulus Serial Communications modules with UPS have a built-in battery backup function, with charger, to keep them running from an external sealed lead-acid (SLA) battery when main power is lost. The module will also supply backup power to any other modules on the bus.



Serial Communications Module with UPS
8x-5140 1DI/PI, 4DI, 3DO, 2AI (20mA)
8x-5240 1DI/PI, 4DI, 3DO, 2AI (V)
8x-5340 1DI/PI, 4DI, 3DO, 2AI (ohms)



Optional Field Wiring Panel

Modulus Serial Communications Module—UPS

- 1 **ETHERNET PORT**
- 3 **SERIAL PORTS (BUS PORT PLUS 2 GENERAL PURPOSE PORTS)**
- 1 **DISCRETE/HIGH-SPEED PULSE INPUT**
- 4 **DISCRETE INPUTS (OPTICALLY ISOLATED)**
- 3 **DISCRETE OUTPUTS (PROTECTED FET)**
- 2 **ANALOG INPUTS (8X-5140-mA, 8X-5240-V, 8X-5340-ohms/temp)**
- 1 **UPS (BACKUP POWER SWITCHING AND BATTERY CHARGER)**

STANDALONE OPERATION

Modulus Serial Communications modules can serve as standalone devices with SCADA communications, local and web human machine interfaces (HMIs), historical trending and data logging, alarming, reporting, and programmable logic.

COMMUNICATIONS

Modulus Serial Communications modules have an Ethernet port and up to three serial ports to communicate with Modbus devices and Allen Bradley PLCs. They can serve as communications concentrators or master controllers, as well as providing web and data access to any other Modulus modules on the high-speed bus. They support Ethernet to Serial bridging, and routing through Ethernet ports in other Modulus modules on the bus.

GRAPHICAL, MOBILE, AND LOCAL HMIs

Configurable graphical and mobile device web interfaces, including the tools and libraries to build custom screens, are built in. The front panel display can also be customized to show live process values and states, and make setting changes.

HISTORICAL TRENDING AND EVENT LOGGING

Modulus Serial Communications modules have an internal flash disk, as well as a micro SD memory card slot to record over 100 years of data! Use built-in web tools to retrieve and display historical trend and event data and extract it as spreadsheet files.

REPORTING

Reports with custom graphics and logos can be created in minutes, showing live values, totals, trend/event data, alarm summaries, etc. They can be called up on demand, or sent out automatically.

ALARMING

A Modulus Serial Communications module can manage alarm conditions on any of its local inputs, as well as over 500 conditions monitored by communications with other devices. Alarms conditions can be displayed locally and annunciated with its discrete output, as well as text message and e-mail alerts over the Internet via its Ethernet port. The module maintains a journal spreadsheet file of when alarms occurred, when they were acknowledged, by whom, and when the alarm conditions cleared.

PROGRAMMABLE LOGIC

Modulus Serial Communications modules support programmable logic written in ladder logic, function block and text languages; all with 32-bit integer and floating point math. Programmable logic can supplement the built-in functions of the module.

PID & PUMP CONTROL

Modulus Serial Communications modules have a quad PID controller and a triplex pump controller (float or level control) with error detection and alarming. The Serial Communications Module is an ideal solution for SCADA operation of wells, lift stations, and booster pump stations.

REDUNDANCY

Modulus Serial Communications modules support redundancy for enhanced reliability. If a module goes off-line, a designated backup can take over automatically.

Modulus Serial Communications Module with UPS - Type 1120 - Specifications

FIELD I/O

Discrete Inputs:	1	High-speed, non-isolated DC or contact closure, DC to 20KHz maximum
Input Range:		Contact closure/open collector driver to ground, or 0 to 30Vdc (ON=<1.5V, OFF > 2.5V)
Input Current:		Approximately 0.5mA (internal current source)
Filtering:		Individually configurable: 5Hz, 10Hz, 20Hz, 50Hz, 100Hz, 500Hz, 1KHz, 2KHz, 5KHz, 10KHz+
	4	Optically Isolated, bipolar (AC/DC, not polarity sensitive)
Input Range:		0 to 30V (OFF < 6V, ON>9V)
Input Current:		1.2mA @ 12V, 3mA @ 24V
Filtering:		Individually configurable: 20Hz or 100Hz
Discrete Outputs:	3	Solid-state Protected FET high-side drivers (switch to input power when ON)
Output Rating:		30Vdc, 2A maximum, current limited to approximately 2.25A.
Analog Inputs:	2	16-bit, Delta Sigma, individually software configurable ranges
Input Range:		<ul style="list-style-type: none">• [8X-5140] 20mA (minimum input for full accuracy is 0.5mA)• [8X-5240] 5V, +/-5V, 10V, +/-10V, 30V• [8X-5340] 50K ohms, temperature using 2.2K, 10K (type II, III and w/11.K shunt) thermistors
Analog Outputs:	2	12-bit
Output Ranges:		<ul style="list-style-type: none">• 0- 20mA, 4-20mA

COMMUNICATIONS

Ethernet:	1	10/100mb/s (10/100 Base-T)
SCADA Protocols		Modbus TCP & UDP (master/slave), Ethernet IP (master/slave PLC5 & SLC5/05 emulation), SDX (AES-128 Encryption), MQTT, Ethernet to Serial bridging
Internet Protocols		HTTP (server), FTP (server & client), E-mail (SMTP and POP3), ICMP (ping; server & client), NTP (client), DHCP (server & client), DNS, DDNS
Serial:	1	RS-232, RS-485, RS-422, SDI-12 (COM1 - general purpose communications port.)
	1	RS-232, RS-485, RS-422 (COM2 - general purpose communications port.)
	1	RS-485 Bus port (this port is available for general purpose communications if not used for high-speed bus communications with other modules)
Baud Rates (all ports)		115K, 38.4K, 19.2K, 9600, 4800, 2400, 1200 baud.
Protocols		Modbus RTU (master/slave), DF1 (slave), SDX (AES-128 Encryption), SDI-12 (general purpose port only)

HMI's

Local:	128x32 graphical, wide temperature range yellow OLED and single pushbutton
Graphical:	Web based, graphic library included. Compatible with most browsers, including Internet Explorer, Firefox, Chrome, Safari, Android
Mobile:	Web based, text only, up to 50 registers. Compatible with most browsers, including Internet Explorer, Firefox, Chrome, Safari, Android

PROGRAMMING

Languages:	Ladder Logic, Function Block, Text—built-in web based graphical and text editor and debugger
Capacity:	64KB logic, 2MB source code, 32-bit integer and floating point math

STORAGE

Registers:	504 Numeric registers, 504 Boolean registers
Internal Flash disk:	32MB
Removable disk:	Micro SD Card (up to 256GB, supplied by customer)

CLOCK

Real Time Clock:	Temperature compensated with lithium battery backup power
Stability	+/- 3ppm from -30°C to 70°C

UPS BATTERY BACKUP

Battery Type Supported:	Sealed Lead-acid (SLA) - Purchase separately; 7AH (p/n 90-9007), 12AH (p/n 90-9012)
Charging Current	0.5A
Backup power to other modules	2A via Modulus bus

GENERAL

Input Power:	10Vdc to 30Vdc (18Vdc minimum for full battery charging)
Power Consumption	
Not using Ethernet	18mA @ 12Vdc / 13mA @ 24Vdc (Ethernet power saver enabled)
Using Ethernet	78mA @ 12Vdc / 43mA @ 24Vdc
Battery Charging	Add up to 600mA @15Vdc / 300mA @24Vdc
Field Wiring Termination:	[81-5x40] screw terminal blocks [82-5x40] lever terminal blocks, 3.5mm, 22 to 14GA wires
Temperature:	-40°C to 70°C (operating), -40°C to 85°C (storage)
Humidity:	<95% RH (non-condensing)
Enclosure:	Polyamide, light gray (RAL 7035)
Mounting:	35mm DIN rail with bus connector block



Specifications subject to change without notice. Consult factory to ensure that you are working with current information.

Modulus Serial Communications Module with UPS - Type 1120—Communications Port Wiring

DIMENSIONS and CONNECTIONS

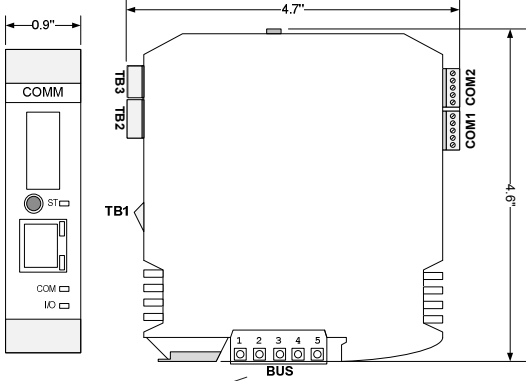

Terminal	Function
1	-485
2	+485
3	RESET#
4	GND
5	+V

Terminals	TB1	TB2	TB3
1	DI1	DO2	DI2
2	AI1	DO3	DI3
3	AI2	BAT+	DI4
4	DO1	BAT-	DI5
5	GND		DIC

General Purpose Communications Port COM1 (modes are software configured)

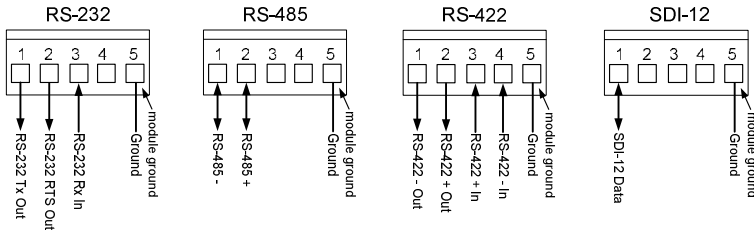

General Purpose Communications Port COM2 (modes are software configured)

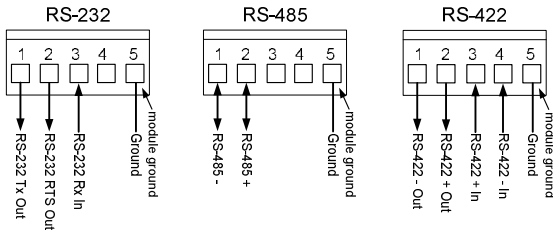

Typical COM1 and COM2 RS-232 Wiring to Modem/

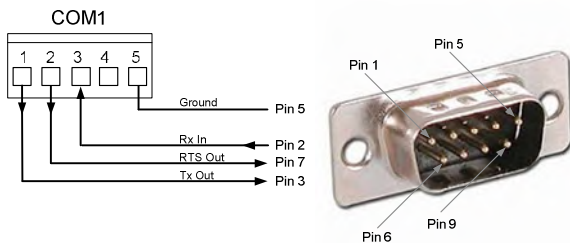

Modulus Serial Communications Module with UPS - Type 1120 - Field Device Wiring

! Refer to the installation manual for additional installation details and precautions.

Discrete Input DI1, Discrete Output DO1 & Analog Inputs —TB1

The field wiring may be connected directly to the TB1 terminal block, or through a field Wiring Panel as shown in the diagrams below. All discrete inputs/outputs and analog inputs are referenced to the ground terminal (5). This terminal is connected internally to the power supply ground.

The Discrete Input accepts a contact closure or open-collector ("NPN" style) input signal. An external pull-up resistor is not required.

The Discrete Output sources current by switching the module input power to the output terminal.

The 8x-5140 model has analog Inputs that accept 20mA current signals. Loop powered (Figure A) and self-powered (Figure C) devices are supported. In power conserving applications, the analog sensors may be powered from the Discrete Output (Figure B), configured to switch power to the sensors only when needed to take an analog reading (with configurable "warmup" time).

The 8x-5240 model has analog Inputs that support voltage sensors (+/-5v, +/-10v and 30v) while the 8x-5340 model supports resistance sensors including thermistor type temperature sensors. The wiring for these sensors is shown in Figure D below.

Note that for loop powered devices, model 82-01xx Field Wiring Panels should be used. For self-powered devices, either model 82-00xx or 82-01xx Field Wiring Panels may be used.

8x-5140 (20mA Analog Inputs)

FIGURE A

20mA Loop Powered Sensors
External Loop Supply

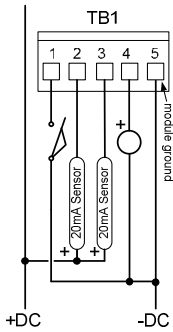

FIGURE B

Sensor Power from
Discrete Output

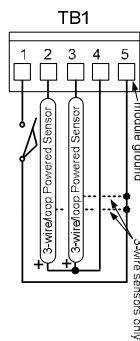
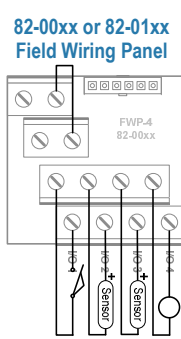
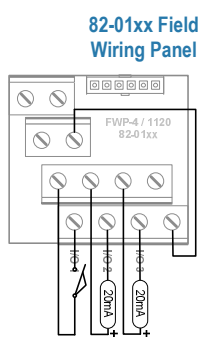
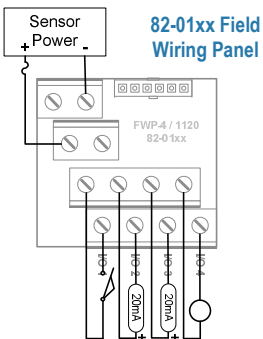
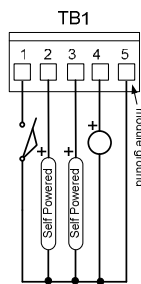

FIGURE C

Self-powered
20mA Sensors



8x-5240 (Voltage) and 8x-5340 (Resistance/Temperature) Analog Inputs

FIGURE D

Voltage and Resistance
Sensor Wiring

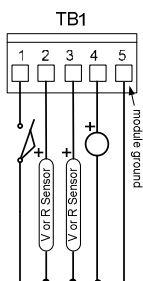

Note:
Resistance sensors
do not have a polarity

**82-00xx or 82-01xx
Field Wiring Panel**

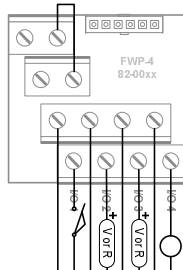

Discrete Outputs DO2 and DO3, Battery—TB2

UPS Comm modules add two FET discrete outputs and battery backup functionality to the base module configuration. The field wiring to these outputs may be connected directly to the TB2 terminal block, or through an 82-02xx Field Wiring Panel as shown in the diagrams below. The cable for the field wiring panel is terminated with a 4-position terminal block plug that plugs into the module, and a separate ground wire that is connected back to the power ground (usually at the base terminal block on the DIN rail).

The Discrete Outputs source current ("PNP" style) by switching the module input power to the output terminals.

A 7AH or 12AH Sealed Lead Acid (SLA) battery should be connected as shown. Do not connect the battery directly to the modules system ground connection.

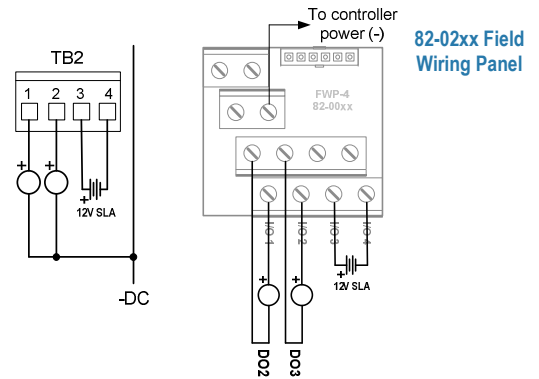

Discrete Inputs DI2 to DI5 —TB3

UPS Comm modules have four optically isolated discrete inputs. The field wiring to these inputs may be connected directly to the TB3 terminal block, or through a Field Wiring Panel as shown in the diagrams below. The common for the discrete inputs is shared among the four inputs but isolated from the rest of the module.

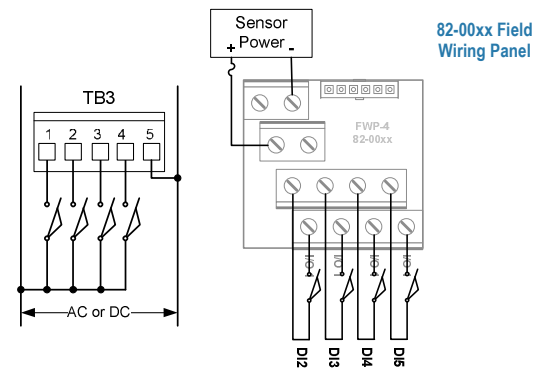

Sensor power may be AC or DC of either polarity. It can be the same source as the module input power.



Industrial Control Links, Inc.
Roseville, CA 530.888.1800