

MODULUS

Cellular Communications Module 2110 with Audio Out

Modulus Cellular Communications modules have a built-in 4G LTE cellular modem for data exchange over the Internet, alarming/notifications by e-mail and text message, and remote access. They also support **wired** communications with Modbus, DF1, Ethernet IP, SDX, MQTT, and SDI-12.

The Cellular Communications modules have built-in analog and digital I/O for tank level and process monitoring, and pump control applications such as wells, lift stations and booster pumping stations. The modules have an analog input supporting both mA and voltage measurement. In addition, they have six discrete inputs (two high-speed and four optically isolated), and a discrete output.

Modulus Cellular Communications modules have a single serial port (bus port). The bus port may be used for general purpose RS-485 communications when not bussed with other Modulus I/O modules.

These modules have 2 high-quality audio outputs that under program control, can play up to 1000 different MP3 audio segments through a public address or audio radio system. They can also vocalize the values of real-time data in any storage register in multiple common languages.



Optional Field Wiring Panel

Verizon Cellular—Audio Out
8x-5031 2DI/PI, 4DI, 1DO, 1AI (20mA/V),

AT&T & International Cellular—Audio Out
8x-5032 2DI/PI, 4DI, 1DO, 1AI (20mA/V)

Modulus Cellular Communications Modules—Audio Out

- 1 ETHERNET PORT
- 1 4G LTE CELLULAR MODEM (VERIZON OR AT&T / INT'L)
- 1 SERIAL RS-485 PORT (BUS PORT)
- 2 DISCRETE/HIGH-SPEED PULSE INPUTS
- 4 DISCRETE INPUTS (OPTICALLY ISOLATED)
- 1 DISCRETE OUTPUT (PROTECTED FET)
- 1 ANALOG INPUT (mA, V)
- 2 AUDIO OUTPUTS (STEREO)

STANDALONE OPERATION

Modulus Cellular Communications modules can serve as standalone devices with SCADA communications, local and web human machine interfaces (HMIs), historical trending and data logging, alarming, reporting, and programmable logic.

COMMUNICATIONS

Modulus Cellular Communications modules have a built-in 4G LTE cellular modem that can be ordered to support either Verizon or AT&T / international cellular networks. They also have an Ethernet port and one or two serial ports to communicate with Modbus devices and Allen Bradley PLCs. They can serve as communications concentrators or master controllers, as well as providing web and data access to any other Modulus modules on the high-speed bus. They support Ethernet to Serial bridging, and routing through Ethernet ports in other Modulus modules on the bus.

GRAPHICAL, MOBILE, AND LOCAL HMIs

Configurable graphical and mobile device web interfaces, including the tools and libraries to build custom screens, are built in. The front panel display can also be customized to show live process values and states, and make setting changes.

HISTORICAL TRENDING AND EVENT LOGGING

Modulus Cellular Communications modules have an internal flash disk, as well as a micro SD memory card slot to record over 100 years of data! Use built-in web tools to retrieve and display historical trend and event data and extract it as spreadsheet files.

REPORTING

Reports with custom graphics and logos can be created in minutes, showing live values, totals, trend/event data, alarm summaries, etc. They can be called up on demand, or sent out automatically.

ALARMING

A Modulus Cellular Communications module can manage alarm conditions on any of its local inputs and other Modulus I/O on the bus, as well as external devices via communications. Alarm conditions can be displayed locally, and annunciated by text message, e-mail, and audible (public address) alerts. Alarms can be acknowledged by text message or e-mail, discrete input, or local HMI button. The module maintains a journal spreadsheet file of when alarms occurred, when they were acknowledged, by whom, and when the alarm conditions clear.

PROGRAMMABLE LOGIC

Modulus Cellular Communications modules support programmable logic written in ladder logic, function block and text languages; all with 32-bit integer and floating point math. Programmable logic can supplement the built-in functions of the module.

PID & PUMP CONTROL

Modulus Cellular Communications modules have a quad PID controller and a triplex pump controller (float or level control) with error detection and alarming. The Cellular Communications Module is an ideal solution for SCADA operation of wells, lift stations, and booster pump stations.

REDUNDANCY

Modulus Cellular Communications modules support redundancy for enhanced reliability. If a module goes off-line, a designated backup can take over automatically.

Modulus Cellular Communications Module with Audio Out - Type 2110- Specifications

FIELD I/O

Discrete Inputs:	2	High-speed, non-isolated DC or contact closure, DC to 20KHz maximum
Input Range:		Contact closure/open collector driver to ground, or 0 to 30Vdc (ON=<1.5V, OFF > 2.5V)
Input Current:		Approximately 0.5mA (internal current source)
Filtering		Individually configurable: 5Hz, 10Hz, 20Hz, 50Hz, 100Hz, 500Hz, 1KHz, 2KHz, 5KHz, 10KHz+
	4	Optically Isolated, bipolar (AC/DC, not polarity sensitive)
Input Range:		0 to 30V (OFF < 6V, ON>9V)
Input Current:		1.2mA @ 12V, 3mA @ 24V
Filtering		Individually configurable: 20Hz or 100Hz
Discrete Outputs:	1	Solid-state Protected FET high-side driver (switch to input power when ON)
Output Rating:		30Vdc, 2A maximum, current limited to approximately 2.25A.
Analog Inputs:	1	16-bit, Delta Sigma, individually software configurable ranges
Input Range:		• 20mA (minimum input for full accuracy is 0.5mA) • 5V, +/-5V, 10V, +/-10V, 30V

COMMUNICATIONS

Ethernet:	1	10/100mb/s (10/100 Base-T)
SCADA Protocols		Modbus TCP & UDP (master/slave), Ethernet IP (master/slave PLC5 & SLC5/05 emulation), SDX (AES-128 Encryption), MQTT, Ethernet to Serial bridging
Internet Protocols		HTTP (server), FTP (server & client), E-mail (SMTP and POP3), ICMP (ping; server & client), NTP (client), DHCP (server & client), DNS, DDNS
Cellular:	1	4G LTE: [8x-5031] 700(B13)/AWS1700(B4)/1900(B2) (Verizon)
		4G LTE: [8x-5032] 700(B12/B13)/850(B5)/AWS1700(B4)/1900(B2) (AT&T, T-Mobile, International)
SCADA Protocols		Modbus TCP & UDP (master/slave), MQTT
Internet Protocols		HTTP (server), FTP (server & client), E-mail (SMTP and POP3), ICMP (ping; server and client), DNS, DDNS
Serial:	1	RS-485 Bus port (this port is available for general purpose communications if not used for high-speed bus communications with other modules)
Baud Rates (all ports)		115K, 38.4K, 19.2K, 9600, 4800, 2400, 1200 baud.
Protocols		Modbus RTU (master/slave), DF1 (slave), SDI-12 (general purpose port only)
Audio:	2	18-bit audio outputs, <0.2% Total Harmonic Distortion
File Storage		Dedicated 32MB internal flash disk; up to 1000 audio file segments
File Format		MP3 compressed audio with automatic sample rate detection and playback; 320 kbit/s maximum
Output Levels and Load		1.6Vpp into 30 ohms with electronic programmable attenuation and tone controls

HMI

Local:	128x32 graphical, wide temperature range yellow OLED and single pushbutton
Graphical:	Web based, graphic library included. Compatible with most browsers, including Internet Explorer, Firefox, Chrome, Safari, Android
Mobile:	Web based, text only, up to 50 registers. Compatible with most browsers, including Internet Explorer, Firefox, Chrome, Safari, Android

PROGRAMMING

Languages:	Ladder Logic, Function Block, Text—built-in web based graphical and text editor and debugger
Capacity:	64KB logic, 2MB source code, 32-bit integer and floating point math

STORAGE

Registers:	504 Numeric registers, 504 Boolean registers
Internal Flash disk:	32MB
Removable disk:	Micro SD Card (up to 256GB, supplied by customer)

CLOCK

Real Time Clock:	Temperature compensated with lithium battery backup power
Stability	+/- 3ppm from -30°C to 70°C

GENERAL

Input Power:	10Vdc to 30Vdc
Power Consumption	
Not using Ethernet	68mA @ 12Vdc / 40mA @ 24Vdc (Ethernet power saver enabled)
Using Ethernet	108mA @ 12Vdc / 60mA @ 24Vdc
Field Wiring Termination:	[81-503x] screw terminal blocks [82-503x] lever terminal blocks, 3.5mm, 22 to 14GA wires
Antenna Connector:	SMA female (female pin center conductor)
Temperature:	-40°C to 70°C (operating), -40°C to 85°C (storage)
Humidity:	<95% RH (non-condensing)
Enclosure:	Polyamide, light gray (RAL 7035)
Mounting:	35mm DIN rail with bus connector block



Specifications subject to change without notice. Consult factory to ensure that you are working with current information.

Modulus Cellular Communications Module with Audio Out - Type 2110—Antenna Wiring

DIMENSIONS and CONNECTIONS

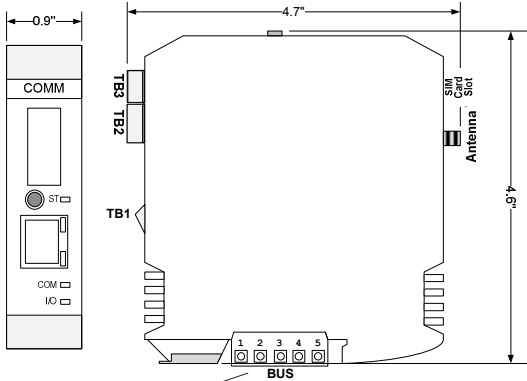

Terminal	Function
1	-485
2	+485
3	RESET#
4	GND
5	+V

Terminals	TB1	TB2	TB3
1	DI1	AUDIO L	DI3
2	DI2	AUDIO R	DI4
3	AI1	PTT	DI5
4	DO1	GND	DI6
5	GND		DIC

Antenna System Options

Most cellular based systems typically have less costly and complex antenna system requirements. The choice of antenna components depends on the type of enclosure housing the enclosure (metallic or non-metallic) and the proximity to the nearest cellular tower.

Non-metallic Enclosure

When installed in a non-metallic enclosure, the simplest and lowest cost antenna solution is a whip antenna screwed directly into the SMA antenna connector on the module. The part number is **98-3411**.



Metallic enclosure—standard.

If the module is installed in a metallic enclosure, many applications can use a low-cost "salt-shaker" style antenna (part number **98-3402**), mounted on the enclosure. The antenna is connected to the communications module with a short internal antenna cable (part number **98-6136**).



"salt shaker" antenna

Metallic enclosure—difficult reception areas.

Sometimes, the site location may not be close to the carriers cellular tower. This may require a higher performance antenna system using a Yagi directional antenna elevated on a support pole or structure.. You will need to aim the antenna towards the desired cellular tower (the carrier can help you identify the tower location). A lightning arrestor is generally recommended since the antenna is elevated, making it a better "target" for a lightning strike. Use a dedicated grounding rod and bonding as shown for the lightning arrestor.

Antenna System BOM:

- 98-6136** 36" Internal Antenna Cable
- 98-8011** Lightning Arrestor
- 98-42xx** Low-loss Antenna Cable (xx= length in feet)
- 98-3409** Cellular Yagi Antenna w/ weather radome
- 98-9002** Weatherproofing Kit (for external antennal connections)

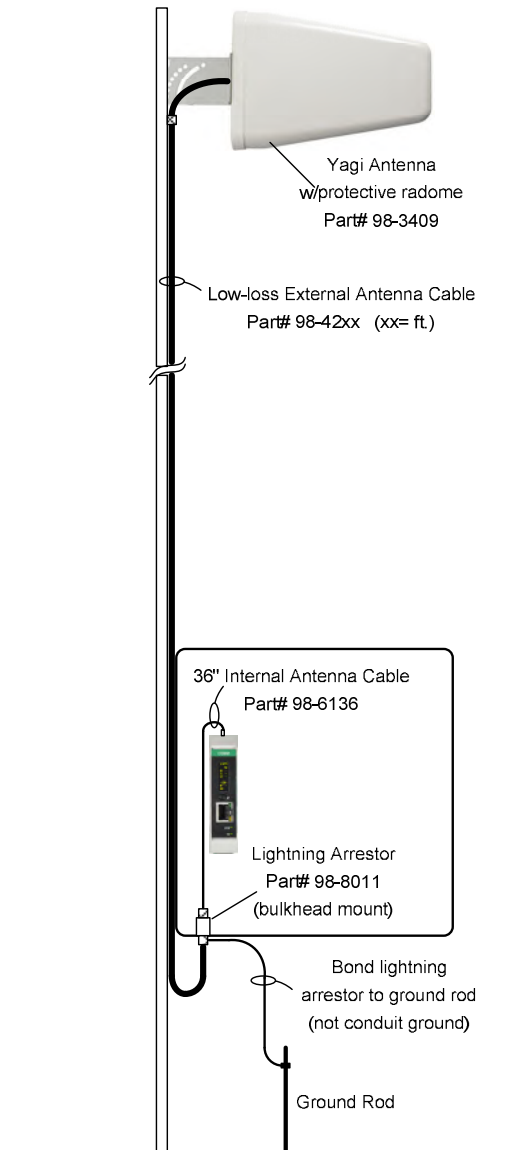

Modulus Cellular Communications Module with Audio Out - Type 2110 - Field Device Wiring

! Refer to the installation manual for additional installation details and precautions.

Discrete Inputs DI1 & DI2, Discrete Output DO1 & Analog Input AI1 - TB1

The field wiring may be connected directly to the TB1 terminal block, or through a field Wiring Panel as shown in the diagrams below. All discrete inputs/outputs and the analog input are referenced to the ground terminal (5). This terminal is connected internally to the power supply ground.

The Discrete Inputs accept contact closures or open-collector ("NPN" style) input signals. External pull-up resistors are not required.

The Discrete Output sources current by switching the module input power to the output terminal.

The analog Input accepts 20mA current or voltage (+/-5v, +/-10v and 30v) signals. The mode is software selectable. Sensors can be either loop powered (Figure A) or self-powered (Figure C). In power conserving applications, the analog sensor may be powered from the Discrete Output (Figure B), configured to switch power to the sensor only when needed to take an analog reading (with configurable "warmup" time (a 20mA loop powered sensor is shown below, but a voltage sensor can also be used by switching its power)).

Note that for all configurations, the model 82-00xx Field Wiring Panel is used.

FIGURE A
20mA Loop Powered Sensors
External Loop Supply

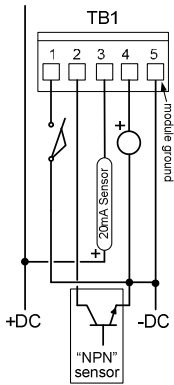

82-00xx Field
Wiring Panel

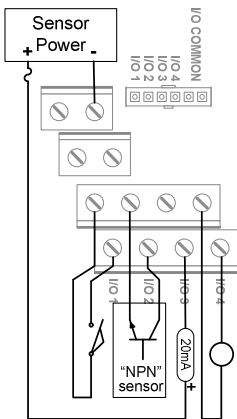
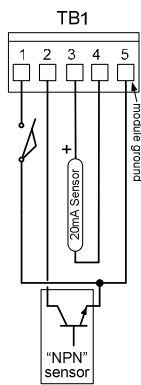

FIGURE B
Analog Sensor Power
from Discrete Output
(power saver)



82-00xx Field
Wiring Panel

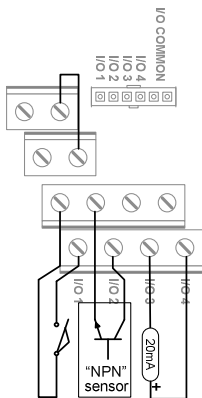
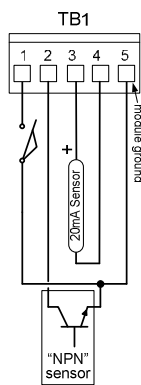
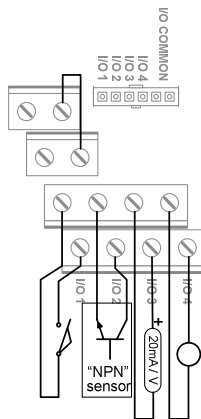

FIGURE C
Self-powered
Sensors



82-00xx Field
Wiring Panel



Audio and Push-to-Talk Outputs—TB2

Audio Out Comm modules add two high-quality audio output channels and a transistor "open collector" Push-to-Talk discrete output to the base module. These can be used to announce audio messages over a public address or audio radio system. The field wiring to these outputs may be connected directly to the TB2 terminal block, or through an 82-02xx Field Wiring Panel as shown in the diagrams below.

The Audio Outputs have both left and right channels, along with a "Push-to-Talk" open collector output that will switch to ground when audio is playing. This can be used to activate the output of a public address amplifier, or key an audio radio transmission when audio is being played.

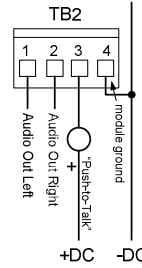

82-02xx Field
Wiring Panel

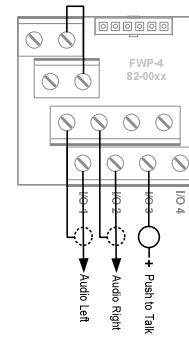

Discrete Inputs DI3 to DI6—TB3

Audio Out Comm modules have four optically isolated discrete inputs. The field wiring to these inputs may be connected directly to the TB3 terminal block, or through a Field Wiring Panel as shown in the diagrams below. The common for the discrete inputs is shared among the four inputs but isolated from the rest of the module.

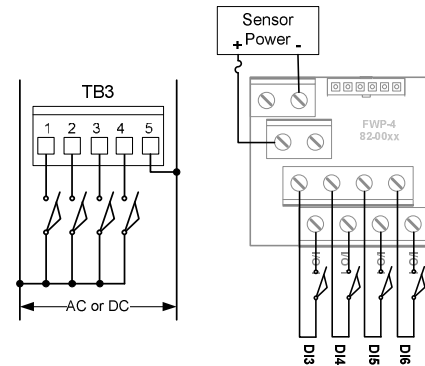

82-00xx
Field

Sensor power may be AC or DC of either polarity. It can be the same source as the module input power.



Industrial Control Links, Inc.
Roseville, CA 530.888.1800